



Kriwan Testzentrum

Automotive

CISPR 25 ESA | CISPR 25 VEHICLE | AUTOMOTIVE

Our EMC Test Sites offer much more than the sum of components, products, services and integration. Our solution philosophy begins with the initial customer inquiry and continues through the entire process to include maintenance service and a lifelong commitment to our customer's EMC facilities.

Chamber Overview

STANDARDIZATION MAKES CUSTOMIZED SOLUTIONS AFFORDABLE.

Today, we directly control the R&D and manufacturing of the two principal components found in any EMC facility solution namely the shielding and the RF absorbers. Additionally, we work closely with our suppliers in the development of the components (i.e. RF filters, turntables, antenna masts, etc.), to insure they meet our stringently defined specifications.

The family of EMC Test Sites for the automotive industry and their suppliers of electric and electronic assemblies includes semi-anechoic chambers (SAC) for 1 m, 3 m, 5 m and 10 m test distance. For 20 years, the automotive industry has considered the semi-anechoic chamber as "state-of-the-art" for vehicle testing and the same has held true for component testing for the last decade. The distinction between the so-called CISPR 25 and automotive chamber is caused by the significant difference in size, cost, and the variety of measurements to be performed.

The CISPR 25 chambers are mainly used for emission measurements on electronic subassemblies (ESA) and for comprehensive emission measurements on vehicle's inner EMC. The EMS tests are mostly performed with the vehicle placed on a chassis dynamometer.

The boosting ESA in vehicles makes the "inner EMC" of vehicles the challenge of today. The vehicle is driven by the chassis dynamometer to simulate various traffic situations and cover all functional stresses. All CISPR 25 and automotive test sites provide a shielding compliant to EN 50147-1 and IEEE 299. Conducted EMC measurements, according to all of the relevant standards can be performed in all chambers, provided that the geometry of the test site and its configuration allows it.

Chamber Validation

A WIN-WIN SITUATION FOR BOTH CUSTOMER AND SUPPLIER.

The chamber validation procedure and test reports serve many functions but most importantly, are proof positive that we fulfill our contractual obligation to the client by providing a high performance RF chamber.

In order for the customer to receive accreditation for their chamber, it is necessary that the chamber undergo final verification testing by an independent third party who will certify conformity to the required standards.

As an EMC Test Site solution provider, we consider the validation procedure to be the final and irrevocable quality control of the chamber design, selected materials and installation skills. From the very beginning, we have invested considerable resources in the capability of independently performing the chamber validation procedure according to the recognized international standards. Our record of more than 200 continuous chamber validations over the past ten years furthers our understanding of the behavior of an anechoic chamber. Our close cooperation with globally recognized independent test houses ensures a continuous and accurate cali-

bration of our measuring antennas. We offer chamber validation service wherever requested and appropriate. Our participation in the international Standard Committees (CISPR/IEC) contributes to the evolution of the validation procedures. Consequently, all our CISPR 25 and automotive test sites are designed to meet or exceed the performance criteria set in those relevant standards.

Historically the automotive industry developed their own standards for the validation of test sites. These validation procedures are significantly different to the methods which are described in the CISPR-16-1-4 and IEC 61000-4-3.

The automotive standard CISPR 25 introduced the concept of the absorber lines shielded enclosure (ALSE) and defined the minimum dimensions and performance of the ALSE. Additionally, the validation procedures for EMI and the reference measurement method (RMM) are defined in CISPR 25. The validation procedures are given for vehicle chambers as well as for chambers to test electronic sub assemblies (ESA).

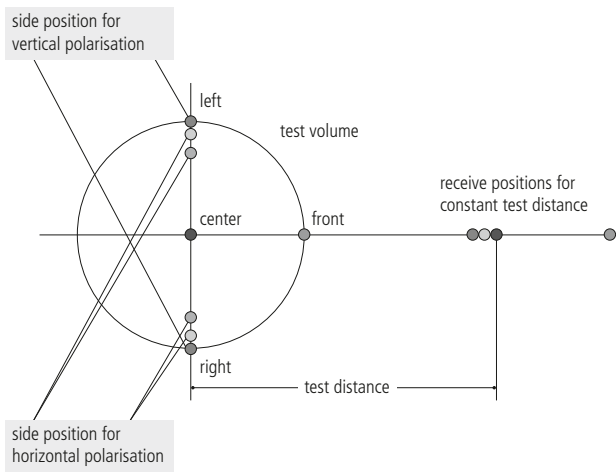

Basic set-up for test volume measurement

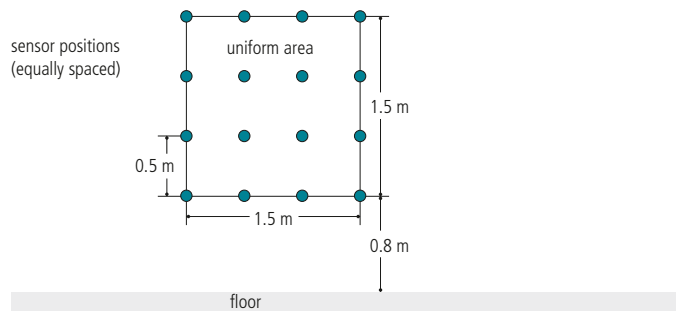

Uniform area for field uniformity test

Similar procedures are mentioned in the SAE J551. These standards specify the use of traditional antennas, biconical and log-periodic, similar to the CISPR 16-1-4.

Recently, the automotive CISPR committee launched an alternative procedure for test site validation. The procedure calls for the use of a modeled long wire instead of a traditional antenna, this test is known as the long wire method (LWM). The LWM and RMM procedures are an annex to the latest CD 391 which is soon expected to become the new CISPR 25 standard. On request, our CISPR 25 chambers can be validated according to this method. (Please refer to page 10 of this brochure)

For a large automotive 3 m, 5 m, and 10 m test sites, the validation procedure according to the ALSE concept would not yield an indication of the quality of the chamber design. Therefore it became state-of-the-art to validate these chambers for EMI according to the CISPR 16-1-4 defining a test volume which is likely to be the size of the EUT or close to it.

The chamber requirements for EMS tests on components and vehicles are called out in ISO 11451/11452, SAE J551 and SAE J1113, although no validation procedure is mentioned. The hybrid absorbers used for our CISPR 25 chambers show reflectivity values far below the requirements set in the above mentioned standards (-10 dB).

The large automotive chambers for 3 m, 5 m and 10 m test distance are validated for EMS in reference to the IEC 61000-4-3 standard. Obviously the size of the homogeneous area greatly exceeds the 1.5 m x 1.5 m (5 ft x 5 ft) set down for industrial equipment and its common practice to use a window technique to determine the homogeneity criterion. In such cases the appropriate size of the floor absorber lay-out must be considered.

An overview of different test set-ups is shown below.

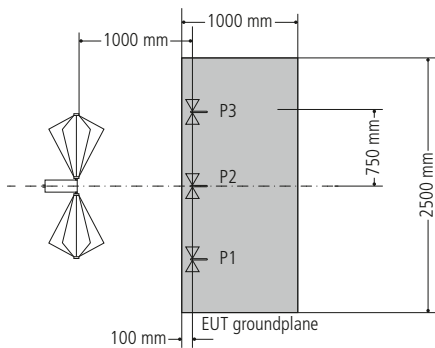

Set-up for RMM reference method measurement

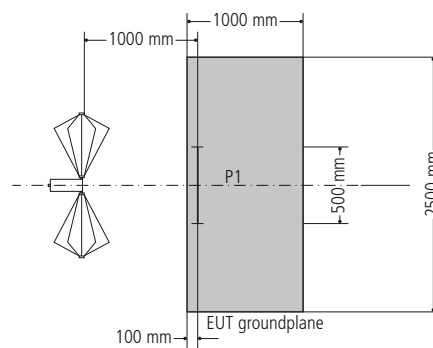

Set-up for LWM long wire measurement

Purpose & Standards

WHAT IS THIS SOLUTION FOR?

Electro Magnetic Compatibility is the ability of electrical and electronic equipment and systems to share the electromagnetic spectrum and perform their desired functions without unacceptable degradation to or from the specified electromagnetic environment. This basic statement must be implemented by manufacturer and dealer into all electrical and electronic equipment brought into the market. For the automotive market this implementation is a matter of survival.

Today's cars are equipped with many electronic systems for multimedia entertainment as well as many active and passive safety functions. There can be no compromise in this regard. Our automotive and CISPR 25 test sites are configured to aid in producing the most accurate design on those safety functions.

The high shielding effectiveness of the pan shielding system is at least 100 dB up to 40 GHz. This allows our customers to perform any kind of automotive measurements and tests from BCI over stripline to radiated EMS tests over 300 V/m.

In addition to the internationally recognized standards, the automotive market is driven by specific "company" requirements. More and more antennas need to be integrated into a vehicle. Many applications such as keyless entry and distance radar, cover frequency ranges far above 40 GHz. Additionally, there are an increasing number of info-tainment services (e.g. traffic control radar, GPS, GSM, UMTS, Radio/TV). All these applications, besides the standard EMC tasks call for multipurpose anechoic test sites capable of performance from 30 MHz to 75 GHz, challenging the absorber's broadband performance. We have specific solutions available to meet all of these demanding requirements.

In our chambers measurements can be performed on ESA and vehicles according to the following international standards and directives can be performed: CISPR 12, CISPR 25, ISO 11451/11452, ISO 7637, SAE J551, SAE J1113, 2000/2EC, 2002/24EC, 2003/77EC, 2004/104EC. Some OEM specifications for which our chambers are suitable: TL 82066, TL 82166, DC 10613, DC 10614, AV EMC EN, ES-XW7T-1A278-AC, GMW3097.

Quality Management

QUALITY MEANS DOING IT RIGHT FROM THE VERY FIRST THOUGHT.

Our quality management ensures a most efficient quality control over products, management and organizational systems.

The organization ensures the availability of resources and information necessary to support the operation and monitoring of these processes. All relevant processes are defined in our management system. Through monitoring, analysis, and improvement, the highest quality and customer satisfaction is our target.

In an effort to improve our quality assurance systems, we ask our customers to provide an evaluation of our performance at the conclusion of each project. This feedback, coupled with input from the market and the Standards Committees, gives continuous enhancement to our systems and correction to any non-conformity found.

Product purchasing and sourcing is a priority in our role as system integrator, so much that it encompasses one of sixteen chapters in our quality management system. Key process figures are:

- audit & approval of suppliers
- evaluation of products by our technical team
- technical reporting on delivered products
- project related factory acceptance by the project manager.

Our ISO 9001 certification guarantees that our designs, products, and solutions will always meet the highest quality standards. It's our goal to provide you the very best of expertise, project management, and products. The main system components like shielding, absorbers etc. are manufactured by daughter companies or by our shareholders. This ensures a full control with regard to quality and delivery time.

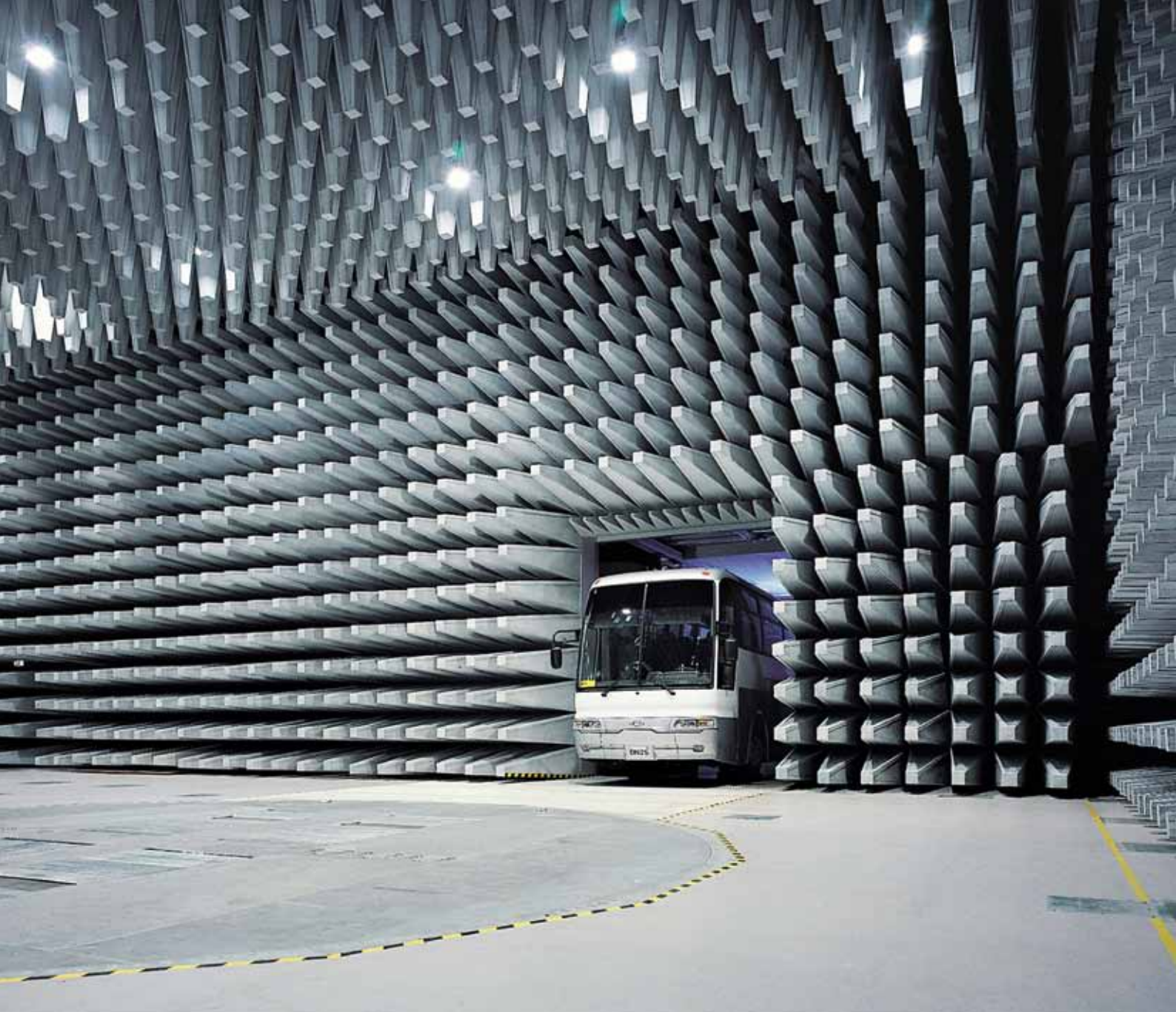



CISPR 25

CISPR 25

The CISPR 25 recommendation on the anechoic lined shielded enclosure (ALSE) for measurements on ESA and vehicles is a semi-anechoic chamber (SAC) with high quality ground plane. Walls and floors need to provide a reliable grounding interface for the EUT test table. The new testing methods set in the CD 391 calls for hybrid absorbers due to their strong performance in the low MHz range.

Basic Outline CISPR 25

KEY FEATURES

- Self-supporting modular pan shielding for floor, walls and ceiling inclusive of an earthing stud
- High quality ground plane on a raised floor with distributed load of 2 t (4,409 lb) with enhanced grounding as to CISPR 25 requirements
- Reinforced raised floor according to turntable load between main entrance and turntable
- Floor connection points and wall access panels as to chamber size
- Honeycomb vents in walls and ceiling 0.33 m x 0.33 m (12 in x 12 in) as to the chamber size
- One manually operated RF shielded EUT double winged door 2.7 m x 2.5 m (9 ft x 8 ft) inclusive of a access ramp (vehicle chamber)
- One manually operated RF shielded EUT door 1.2 m x 2.05 m (4 ft x 7 ft) for ESA chamber
- One door maintenance kit
- Hybrid absorber lining for walls and ceiling, designed to the chamber performance
- EUT table grounding interface; according to the standard
- EMC power line filters: one filter 3 phase 32 A for EUT supply and one 2 phase 16 A for internal use
- One set of connectors including one six-fold fiber optic connector, two N-precision connectors and two BNC connectors
- Standard electrical package: electrical distribution, lighting, emergency and signal lamps
- Installation of the ALSE including leakage test after shielding installation

Option CISPR 25

CUSTOMIZABLE UPGRADES

- Fully functional shielded control room
- Digital CCTV monitoring system
- FO converter for Ethernet, GPIB, RS232, VGA, USB, MM and Digi 88
- EMC filters for control- and communication lines
- Fire detection and extinguishing system
- Honeycomb fan for forced ventilation
- Heating, ventilation and air conditioning system (HVAC)
- Painted hybrid absorbers
- Exterior paint on the visible shielding surfaces
- SE measurement according to EN 50147-1, IEEE 299
- Chamber validation according to CISPR 16-1-4, ANSI C63.4
- Chamber validation according to IEC 61000-4-3

CISPR 25 chamber

ROOM DIMENSIONS

Room type	Total required space ¹⁾	Shielding external ²⁾	Clear internal ³⁾
CISPR 25 ESA	5.50 m x 4.30 m x 3.50 m 18.04 ft x 14.11 ft x 11.48 ft	5.50 m x 4.30 m x 3.30 m 18.04 ft x 14.11 ft x 10.83 ft	4.62 m x 3.42 m x 2.86 m 15.16 ft x 11.22 ft x 9.38 ft

L x W x H ¹⁾Dimensions including steel structure, gate drive track and HVAC ducts. ²⁾Dimensions excluding steel structure. ³⁾Absorber to absorber, i.e. ground plane to absorber.

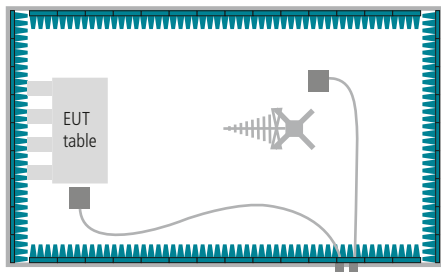

PERFORMANCE

Site Attenuation (ALSE validation)			
Standard	CISPR 25	CISPR 25	CISPR 25
Frequency range	150 KHz – 30 MHz	30 MHz – 1000 MHz	1 GHz – 2.5 GHz
Test distance	1 m	1 m	1 m
Test bench size	2.5 m x 1.0 m	2.5 m x 1.0 m	2.5 m x 1.0 m
Test axis	In axis	In axis	In axis
Deviation	±6 dB	±6 dB	±6 dB

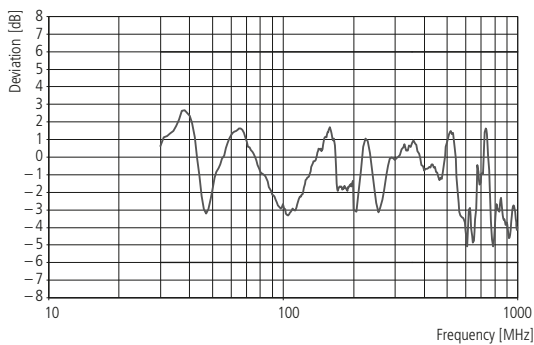

Deviation according to reference method measurement (RMM)

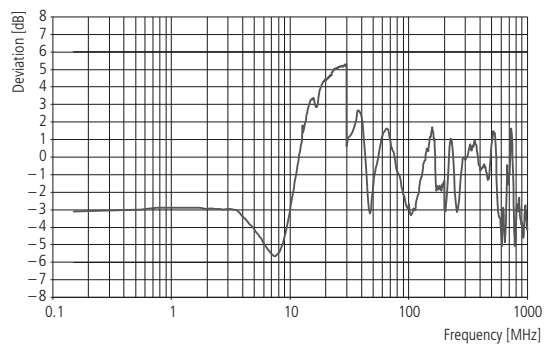

Deviation according to long wire measurement (LWM)

CISPR 25 vehicle chamber

ROOM DIMENSIONS

Room type	Total required space ¹⁾	Shielding external ²⁾	Clear internal ³⁾
CISPR 25 vehicle	8.1 m x 7.8 m x 3.8 m 26.57 ft x 25.59 ft x 12.47 ft	7.9 m x 6.4 m x 3.6 m 25.92 ft x 21.00 ft x 11.81 ft	7.02 m x 5.52 m x 3.03 m 23.03 ft x 18.11 ft x 9.94 ft

L x W x H ¹⁾Dimensions including steel structure, gate drive track and HVAC ducts. ²⁾Dimensions excluding steel structure. ³⁾Absorber to absorber, i.e. ground plane to absorber.

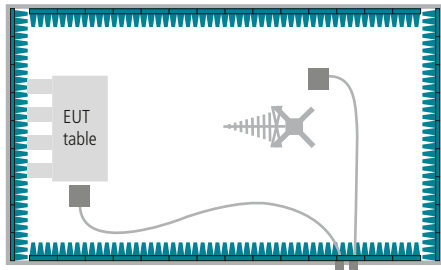

PERFORMANCE

Site Attenuation (ALSE validation)			
Standard	CISPR 25	CISPR 25	CISPR 25
Frequency range	150 KHz – 30 MHz	30 MHz – 1000 MHz	1 GHz – 2.5 GHz
Test distance	1 m	1 m	1 m
Test bench size	2.5 m x 1.0 m	2.5 m x 1.0 m	2.5 m x 1.0 m
Test axis	In axis	In axis	In axis
Deviation	±6 dB	±6 dB	±6 dB

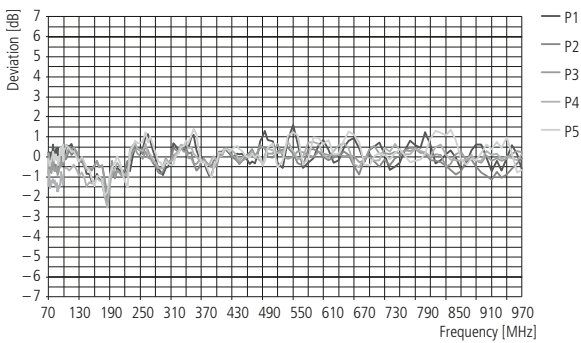

Typical performance CISPR 25 vehicle chamber (RMM)



Automotive

AUTOMOTIVE

The large automotive chambers for 3 m, 5 m and 10 m test distances are classical semi-anechoic chambers (SAC), the most popular alternative test sites for EMC measurements and tests. Their structure and configuration are ideal for large and heavy EUT and commonly equipped with a chassis dynamometer.

Basic Outline Automotive

KEY FEATURES

- Self-supporting modular pan shielding for floor, walls and ceiling inclusive of an earthing stud
- High quality ground plane on a raised floor with distributed load of 3 t (6,613 lb) with enhanced grounding as to automotive requirements
- Reinforced raised floor according to turntable load between main entrance and turntable
- Floor connection points and wall access panels as to chamber size
- Honeycomb vents in walls and ceiling 0.33 m x 0.33 m (12 in x 12 in) as to the chamber size
- One automatic RF shielded EUT sliding gate 2.4 m x 2.4 m (8 ft x 8 ft) inclusive of lift table
- One manually operated RF shielded personnel door 0.9 m x 2.05 m (3 ft x 7 ft)
- One gate and door maintenance kit
- Hybrid and pyramidal absorber lining for floor, walls and ceiling, as to the chamber performance
- Fully functional positioning system including controller, turntable according to test volume size and antenna mast
- EMC power line filters: one filter 3 phase 32 A for EUT supply and one 2 phase 64 A for internal use
- Connectors including a six-fold fiber optic connector, two N-precision connectors and two SMA connectors
- Standard electrical package: electrical distribution, lighting, emergency and signal lamps
- Installation of the SAC including leakage test after shielding installation

Options Automotive

CUSTOMIZABLE UPGRADES

- Fully functional shielded control room
- Fully functional shielded amplifier room
- One additional manually operated RF shielded personnel door 0.9 m x 2.05 m (3 ft x 7 ft)
- Digital CCTV monitoring system
- FO converter for Ethernet, GPIB, RS232, VGA, USB, MM and Digi 88
- EMC filters for control- and communication lines
- Fire detection and extinguishing system
- Lights lowering system for maintenance purpose
- Integrated chassis dynamometer
- Movable chassis dynamometer
- Automatic absorber storage lift
- Heating, ventilation and air conditioning system (HVAC)
- Intercom system
- Painted hybrid absorbers
- Exterior paint on the visible shielding surfaces
- SE measurement according to EN 50147-1, IEEE 299
- Chamber validation according to CISPR 16-1-4, ANSI C63.4
- Chamber validation according to IEC 61000-4-3

5 m Automotive chamber

ROOM DIMENSIONS

Room type	Total required space ¹⁾	Shielding external ²⁾	Clear internal ³⁾
5 m Automotive – 4 m Ø	16.1 m x 10.5 m x 6.5 m 52.82 ft x 32.97 ft x 21.33 ft	15.1 m x 9.1 m x 6.0 m 49.54 ft x 29.86 ft x 19.69 ft	14.07 m x 7.30 m x 5.19 m 46.16 ft x 23.95 ft x 17.03 ft

L x W x H ¹⁾Dimensions including steel structure, gate drive track and HVAC ducts. ²⁾Dimensions excluding steel structure. ³⁾Absorber to absorber, i.e. ground plane to absorber.

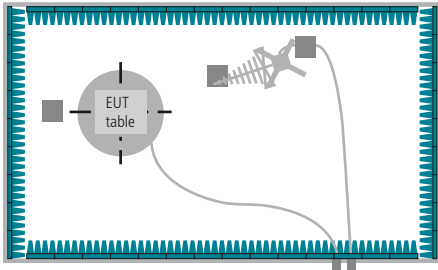

PERFORMANCE

	NSA	Site VSWR	Field Uniformity
Standard	CISPR 16-1-4, ANSI C63.4	CISPR 16-1-4	IEC 61000-4-3 EN 61000-4-3
Frequency range	30 MHz – 1 GHz	1 GHz – 18 GHz	80 MHz – 18 GHz
Test distance	5 m	5 m	3 m
Test volume	4 m	4 m	1.5 m x 1.5 m (vertical plane)
Test axis	Off axis	Off axis	In axis
Deviation	±3 dB	≤ 6 dB	0 to +6 dB / 75% rule

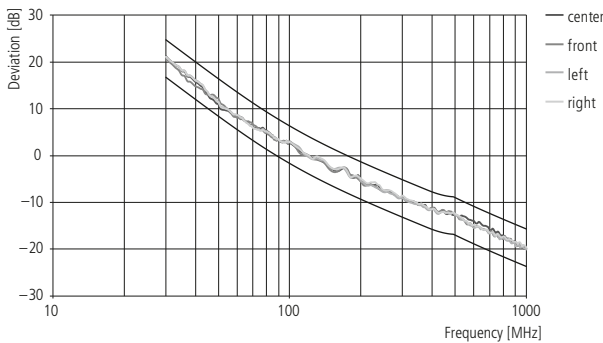

Typical performance Automotive 5 m (NSA)

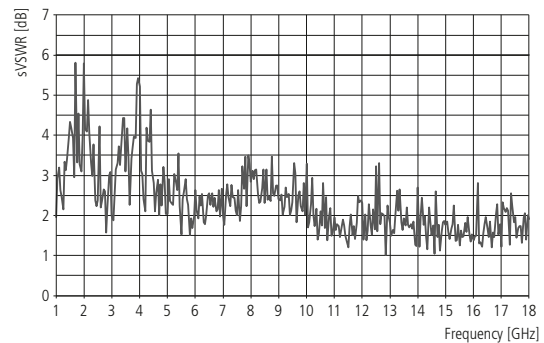

Typical performance Automotive 5 m (sVSWR)

10 m Automotive chamber

ROOM DIMENSIONS

Room type	Total required space ¹⁾	Shielding external ²⁾	Clear internal ³⁾
10 m Automotive – 5.5 m Ø	25.1 m x 16.4 m x 9.5 m 82.35 ft x 53.81 ft x 31.17 ft	24.1 m x 15.4 m x 9.0 m 79.07 ft x 50.52 ft x 29.53 ft	18.80 m x 10.10 m x 5.70 m 61.68 ft x 33.14 ft x 18.70 ft

L x W x H ¹⁾Dimensions including steel structure, gate drive track and HVAC ducts. ²⁾Dimensions excluding steel structure. ³⁾Absorber to absorber, i.e. ground plane to absorber.

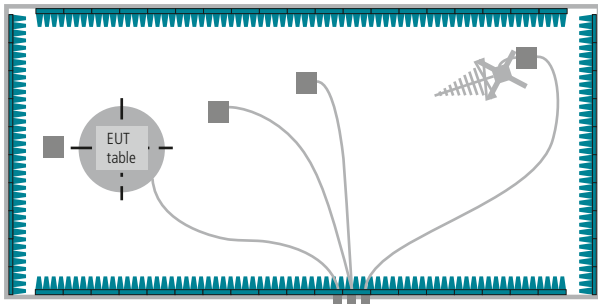

PERFORMANCE

	NSA	Site VSWR	Field Uniformity
Standard	CISPR 16-1-4, ANSI C63.4	CISPR 16-1-4	IEC 61000-4-3 EN 61000-4-3
Frequency range	30 MHz – 1 GHz	1 GHz – 18 GHz	80 MHz – 18 GHz
Test distance	10 m	5 m	3 m
Test volume	5.5 m	5.5 m	1.5 m x 1.5 m (vertical plane)
Test axis	Off axis	Off axis	In axis
Deviation	±3.5d B	≤ 6 dB	0 to +6 dB / 75% rule

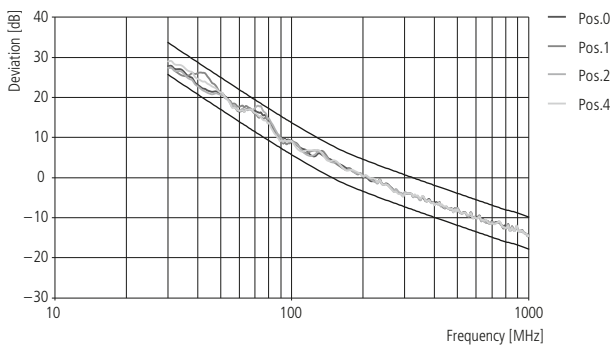

Typical performance Automotive 10 m (NSA)

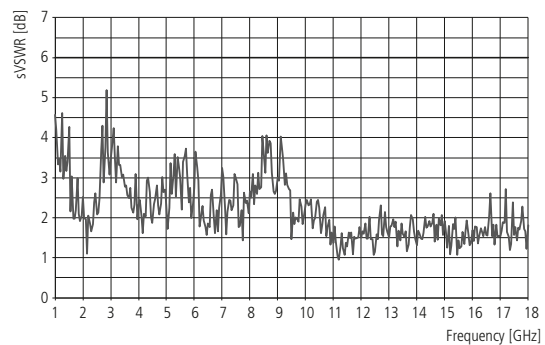

Typical performance Automotive 10 m (sVSWR)

Contact addresses

Albatross Projects GmbH

Daimlerstrasse 17
89564 Nattheim
Germany

Phone +49 7321 730-500
Fax +49 7321 730-590
E-mail info@albatross-projects.com

AP Americas Inc.

1500 Lakeside Parkway, Suite 100-B
Flower Mound, TX 75028
USA

Phone +1 972 295 9100
Fax +1 972 810 3223
E-mail info@apamericas.com

**Albatross Projects RF Technology
(Shanghai) Co., Ltd.**

No. 2998 Longwu Road, Xuhui District
Shanghai 200231, P. R. China

Phone +86 21 6434 1110
Fax +86 21 6434 7800
E-mail info@albatross-projects.com.cn